



VS series

—— Solar Charge Controller

INSTRUCTION MANUAL

Thank you very much for selecting our product!

This manual offers important information and suggestions with respect to installation, use and troubleshooting, etc. Please read this manual carefully before using the product and pay attention to the safety recommendations in it.

VS

—— Solar Charge Controller



Nominal system voltage

12V/24V/48V

Nominal charge / discharge current

10A/20A/30A/40A/50A/60A

Contents

1 Important Safety Information	1
2 General Information	2
2.1 Product Overview	2
2.2 Product Features	3
2.3 Optional Accessories	5
3 Installation Instructions	6
3.1 Mounting	6
3.2 Wiring	8
4 Operation	11
4.1 PWM Technology.....	11
4.2 Battery Charging Information	11
4.3 HMI Interface	13
4.4 Operation and Displaying of Controller	15
➤ System Monitor Interface.....	17
➤ Device Setting Interface.....	20
➤ Charging and Discharging Parameters Setting Interface	22
➤ Load Control Interface	25
➤ Nominal Parameter Interface.....	31
➤ Factory Reset Interface	32
5 Protection, Troubleshooting and Maintenance	34
5.1 Protection	34
5.2 Troubleshooting.....	35
5.3 Maintenance	38
6 Warranty	39
7 Technical Specifications.....	40

1 Important Safety Information

Save These Instructions

This manual contains important safety, installation and operating instructions.

The following symbols are used throughout this manual to indicate potentially dangerous conditions or mark important safety instruction, please take care when meeting following symbols.



WARNING: Indicates a potentially dangerous condition.
Use extreme caution when performing this task.



CAUTION: Indicates a critical procedure for safe and
Proper operation of the controller.

General Safety Information

- Read all of the instructions and cautions in the manual before beginning installation.
- There are no user serviceable parts inside the controller. Do not disassemble or attempt to repair it.
- Install external fuses/breakers as required.
- Disconnect the solar module and fuse/breakers near to battery before installing or adjusting the controller.
- Do not allow water to enter the controller.
- Confirm that power connections are tightened to avoid excessive heating from loose connection.

2 General Information

Thank you for selecting VS series solar charge controller that adopts the most advanced digital technique, displays on the LCD and operates fully automatically. The Pulse Width Modulation (PWM) battery charging and the unique control technology can greatly increase the lifetime of battery. It has various unique functions and easy to use.

2.1 Product Overview

The controller is for off-grid solar system, and protects the battery from being over charged by the solar module and over discharged by the loads. The charging process has been optimized for long battery life and improved system performance. The comprehensive self-diagnostics and electronic protection functions can prevent damage from installation mistakes or system faults.

Features:

- 32 bit MCU with high speed and high performance
- 12 bit A/D high-precision sampling to ensure accuracy
- Excellent EMC design
- Nominal system voltage automatic recognition
- High efficient Series PWM charging, increase the battery lifetime and improve the solar system performance
- Use MOSFET as electronic switch, without any mechanical switch
- Widely used, automatically recognize day/night
- Adopt graphics dot-matrix LCD screen and HMI (human-machine interface) with 4 buttons, integrated menu displaying and operation
- Humanized design of browser interface, undertake every operating conveniently
- Full control parameters setting and modification, diversified load control mode
- Gel, Sealed and Flooded battery type option
- Adopt temperature compensation, correction algorithm for charging and discharging parameters automatically and improve the battery lifetime
- Electronic protection: Overheating, over charging, over discharging, overload, and short circuit.
- Reverse protection: any combination of solar module and battery

2.2 Product Features

VS1024(N) / VS2024(N)

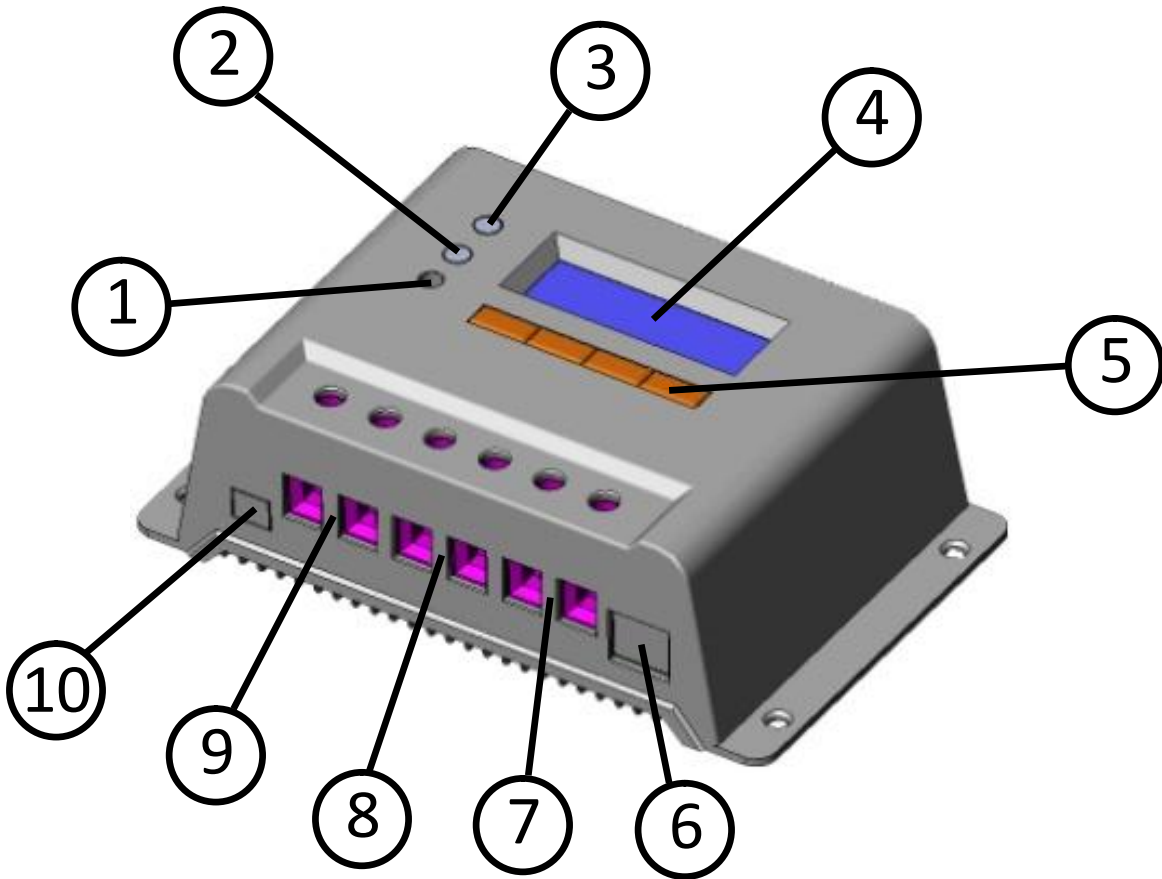

VS2048(N) / VS30**(N) / VS40**(N) / VS50**(N) / VS60**(N)

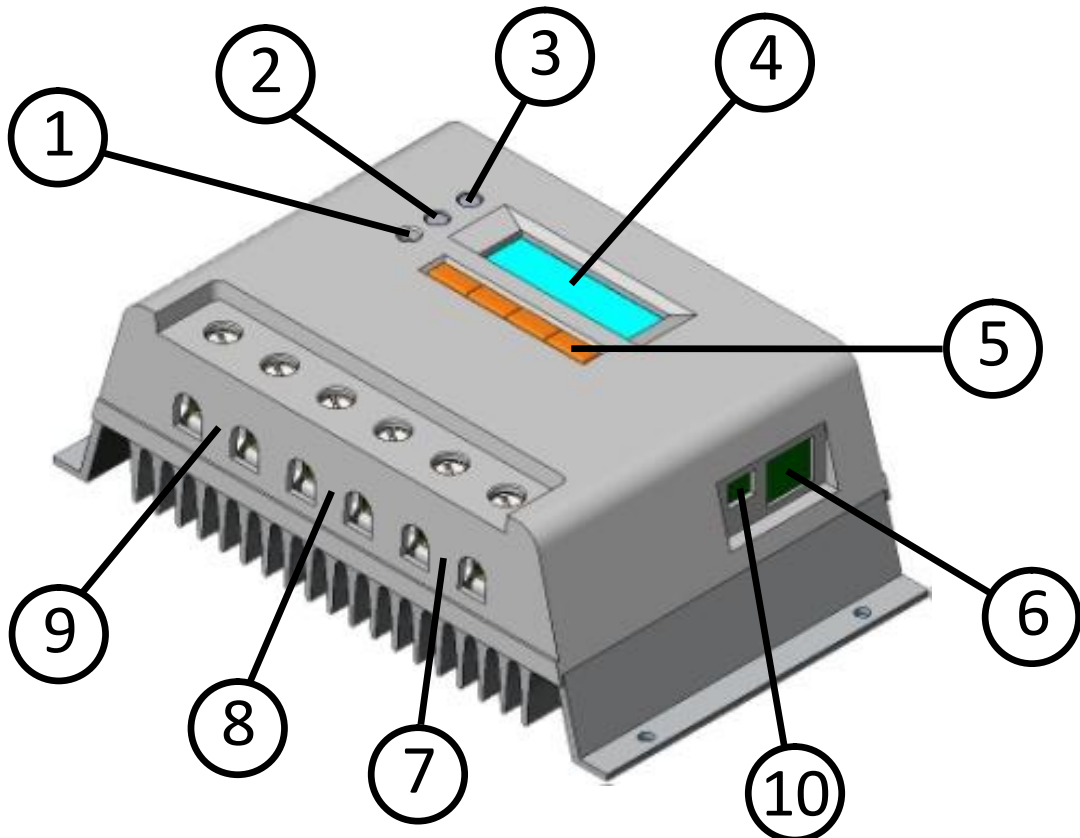

1 – Local temperature sensor

It is used for acquisition of ambient temperature to undertake temperature compensation of charging and discharging parameters, when the remote temperature sensor is not connected

2 – Fault LED indicator

An LED indicator that shows faults of solar system

3 – Charging LED indicator

An LED indicator that shows charging status

4 – Liquid crystal display (LCD)

Monitoring interface for solar system parameters

5 – Combined-type buttons

4 combined-type buttons accomplish all operations to controller

6 – Communication interface

Connect remote displaying unit MT-100 (Optional Accessories)

7 – Load terminals

Connect loads

8 – Battery terminals

Connect batteries

9 – Solar module terminals

Connect solar modules

10 – Remote temperature sensor interface

Connect remote temperature sensor TS-R (Optional Accessories) to acquire of ambient temperature for undertaking temperature compensation of charging and discharging parameters, when it is in connection.

2.3 Optional Accessories

1. Remote Meter(Model : MT-100)

The digital Remote Meter displays system operating information, error indications, and self-diagnostics read-out. Information is displayed on a backlit LCD display. The large numerical display and icons are easy to read and large buttons make navigating the meter menus easy. The meter can be flush mounted in a wall or surface mounted using the mounting frame (included). The MT-100 is supplied with 1.5m of cable and a mounting frame. The MT-100 connects to the RJ45 port on the VS.

2. Remote temperature sensor (Model : TS-R)

Acquiring of ambient temperature for undertaking temperature compensation of charging and discharging parameters, the standard length of the cable is 2m (can be customized if want longer or shorter). The TS-R connects to the 2ERJ—3.81 port on the VS.

3 Installation Instructions

3.1 Mounting

- Read through the entire installation section first before beginning installation.
- Be very careful when working with batteries. Wear eye protection. Have fresh water available to wash and clean any contact with battery acid.
- Use insulated tools and avoid placing metal objects near the batteries.
- Explosive battery gasses may be present during charging. Be certain there is sufficient ventilation to release the gasses.
- Avoid direct sunlight and do not install in locations where water can enter the controller.
- Loose power connections and/or corroded wires may result in resistive connections that melt wire insulation, burn surrounding materials, or even cause fire. Ensure tight connections and use cable clamps to secure cables and prevent them from swaying in mobile applications.
- Use with Gel, Sealed or Flooded batteries only.
- Battery connection may be wired to one battery or a bank of batteries. The following instructions refer to a singular battery, but it is implied that the battery connection can be made to either one battery or a group of batteries in a battery bank.
- Select the system cables according to $3A/mm^2$ current density



NOTE: When mounting the controller, ensure free air through the controller heat sink fins. There should be at least 6 inches (150 mm) of clearance above and below the controller to allow for cooling. If mounted in an enclosure, ventilation is highly recommended.



WARNING: Risk of explosion! Never install the controller in a sealed enclosure with flooded batteries! Do not install in a confined area where battery gassed can accumulate.

Step 1: Choose Mounting Location

Locate the controller on a vertical surface protected from direct sun, high temperature, and water. And make sure good ventilation.

Step 2: Check for clearance

Place the controller in the location where it will be mounted. Verify that there is sufficient room to run wires and that there is sufficient room above and below the controller for air flow.

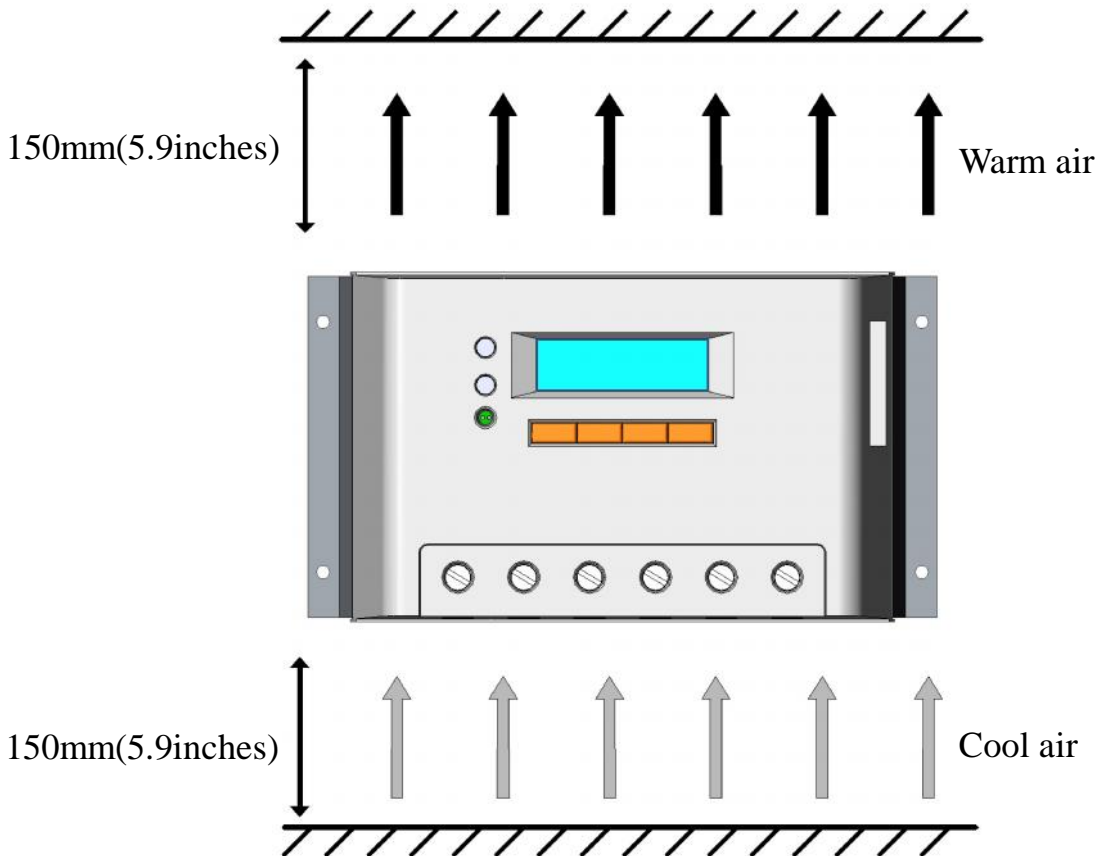

Step 3: Mark Holes

Use a pencil or pen to mark the four (4) mounting hole locations on the mounting surface.

Step 4: Drill Holes

Remove the controller and drill 4mm holes in the marked locations.

Step 5: Secure Controller

Place the controller on the surface and align the mounting holes with the drilled holes in step 4.

Secure the controller in place using the mounting screws.

3.2 Wiring



NOTE: A recommended connection order has been provided for maximum safety during installation.



NOTE: There are two types of the controller: common positive controller and common negative controller.



CAUTION: Don't connect the loads with surge power exceeding the ratings of the controller.



CAUTION: For mobile applications, be sure to secure all wiring. Use cable clamps to prevent cables from swaying when the vehicle is in motion. Unsecured cables create loose and resistive connections which may lead to excessive heating and/or fire.



WARNING: Risk of explosion or fire! Never short circuit battery positive (+) and negative (-) or cables.



WARNING: Risk of electric shock! Exercise caution when handling solar wiring. The solar module(s) high voltage output can cause severe shock or injury. Be careful operation when installing solar wiring.

Before battery is connected, make sure that voltage of battery is higher than 9V so as to start the controller. If nominal system voltage is 24V, make sure that voltage of battery is no less than 18V; if nominal system voltage is 48V, make sure that voltage of battery is no less than 42V. The nominal system voltage can only be automatically identified when controller is started for the first time.

Controller's load terminals can be connected to DC electric equipments whose nominal operation voltage is the same as nominal voltage of battery. The controller supplies power to loads with battery voltage.

It is suggested that positive pole or negative pole of battery and loads should be connected to a safety device, whose operation current is not twice lower than nominal charging or discharging current. Do not switch on the safety device while it is being installed. Switch on the safety device after the wiring is confirmed to be correct.



CAUTION: On occasions that controller must be connected to the ground. For common positive controller, the positive pole must be connected to the ground, on the contrary, the negative pole must be connected to the ground for common negative controller.

***Wire conductor length :**

VS1024(N) : 7mm

VS20(N) : 13mm**

VS30(N) : 10mm**

VS40(N) / VS50**(N) / VS60**(N) : 14mm**

Step 1: Wiring and switching on

After solar system is wired, check carefully all wirings so as to make it clear whether all 6 terminals are correctly connected and tightened. According to the order of switching on in the chart, battery first, loads second and solar module third successively to avoid nominal system voltage identification error.

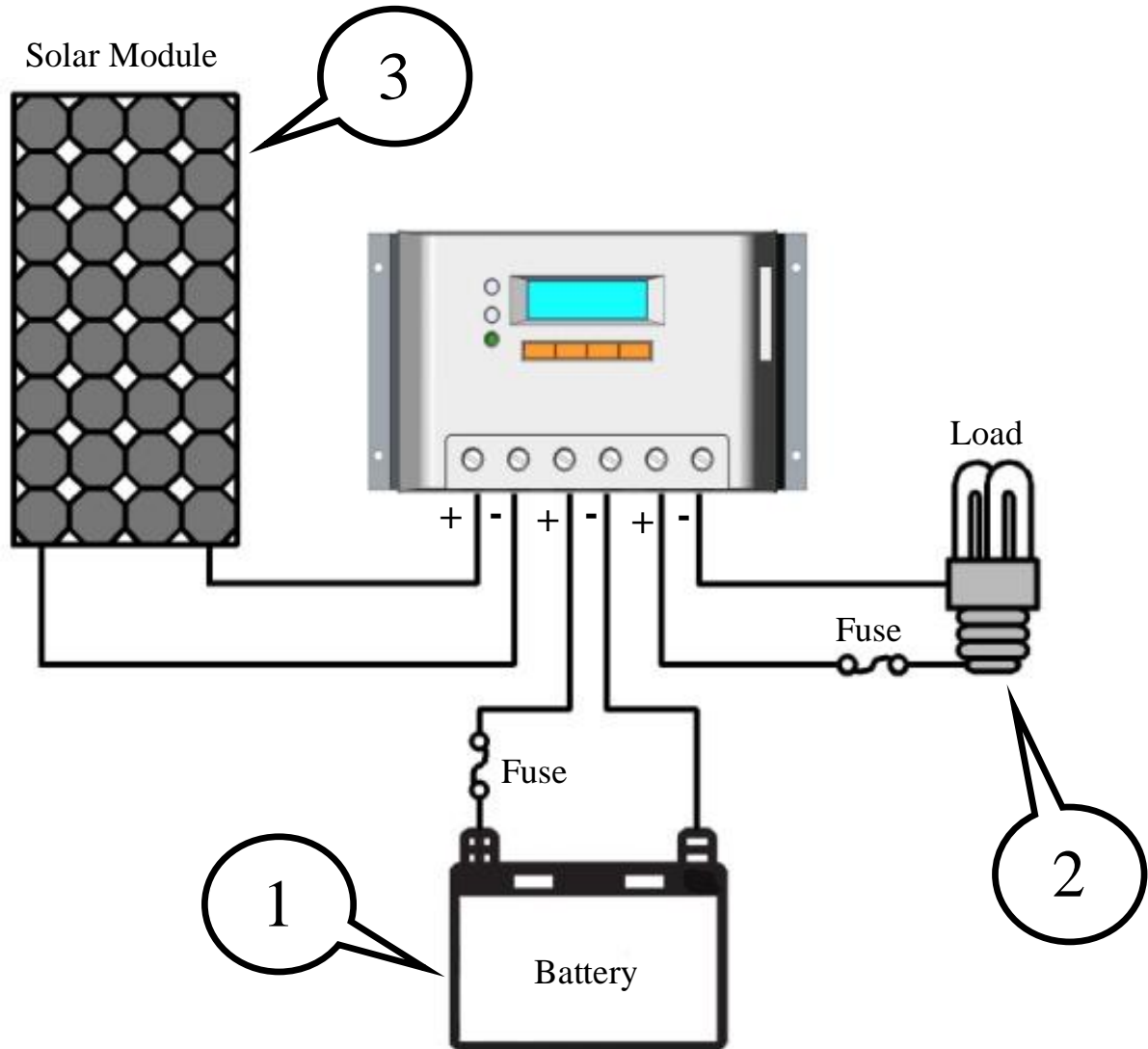

Step 2: Confirming power on

When controller starts up, liquid crystal display (LCD) displays initialization interface and 2 indicator lamps will be lightened once, check if it is correct. If there are no above procedures, refer to section 5 for troubleshooting.

4 Operation

4.1 PWM Technology (Series Pulse Width Modulation)

The controller adopts the advanced series pulse width modulation (PWM) charging mode. With range of 0-100%, it can charge the battery quickly and stably under any condition of solar photovoltaic system.

PWM charging mode use automatic conversion duty ratio pulses current to charge the battery. The battery can be fully charged safety and rapidly with the pulse current. Intermissions make some oxygen and hydrogen generated by chemical reaction chemically combined again and absorbed. It can eliminate concentration polarization and ohm polarization naturally and reduce the internal pressure of the battery so that the battery can absorb more power. Pulse current charging mode makes battery have more time to react, which reduces the gassing volume and makes battery improve the acceptance rate of charging current.

4.2 Battery Charging Information

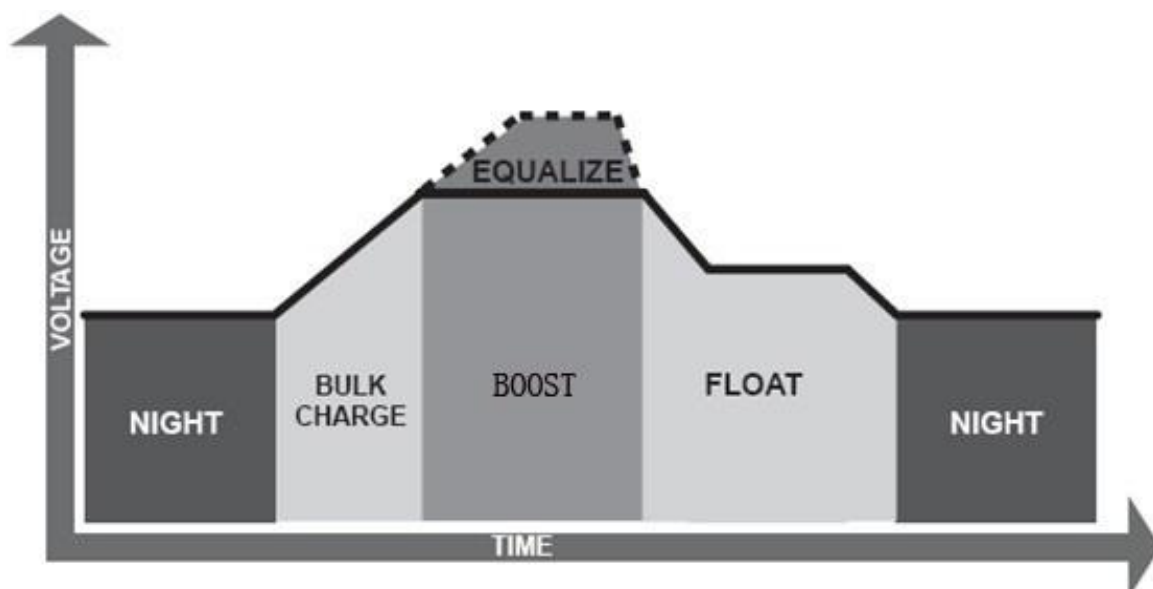

•Bulk Charge

In this stage, the battery voltage has not yet reached boost voltage and 100% of available solar power is used to charge the battery.

•Boost Charge

When the battery has recharged to the Boost voltage setpoint, constant- current regulation is used to prevent heating and excessive battery gassing. The Boost stage remains 120 minutes and then goes to Float Charge. Every time when the controller is powered on, if it detects neither over discharged nor overvoltage, the charging will enter into boost charging stage.

•Float Charge

After the battery is fully charged in Boost voltage stage, the controller reduces the battery voltage to Float voltage set point. When the battery is fully recharged, there will be no more chemical reactions and all the charge current transmits into heat and gas at this time. Then the controller reduces the voltage to the floating stage, charging with a smaller voltage and current. It will reduce the temperature of battery and prevent the gassing, also charging the battery slightly at the same time. The purpose of Float stage is to offset the power consumption caused by self consumption and small loads in the whole system, while maintaining full battery storage capacity.

In Float stage, loads can continue to draw power from the battery. In the event that the system load(s) exceed the solar charge current, the controller will no longer be able to maintain the battery at the Float setpoint. Should the battery voltage remains below the boost reconnect charging voltage, the controller will exit Float stage and return to Bulk charge.

•Equalize Charge



WARNING: Risk of explosion!

Equalizing flooded battery can produce explosive gases, so well ventilation of battery box is necessary.



NOTE: Equipment damage!

Equalization may increase battery voltage to the level damaging to sensitive DC loads. Ensure that all load allowable input voltages are greater than the equalizing charging set point voltage.

NOTE: Equipment damage!



Over-charging and excessive gas precipitation may damage the battery plates and activate material shedding on them. Too high an equalizing charge or for too long may cause damage. Please carefully review the specific requirements of the battery used in the system.

Certain types of batteries benefit from periodic equalizing charge, which can stir the electrolyte, balance battery voltage and complete chemical reaction. Equalizing charge increases the battery voltage, higher than the standard complement voltage, which gasifies the battery electrolyte.

Every month 28th solar controller will engender equalize charging stage. It will remain 120mins when equalize stage is constant, or it will remain 180mins when equalize charging accomplishes off and on. Equalize charge and boost charge are not carried out constantly in a full charge process to avoid too much gas precipitation or overheating of battery.

4.3 HMI Interface

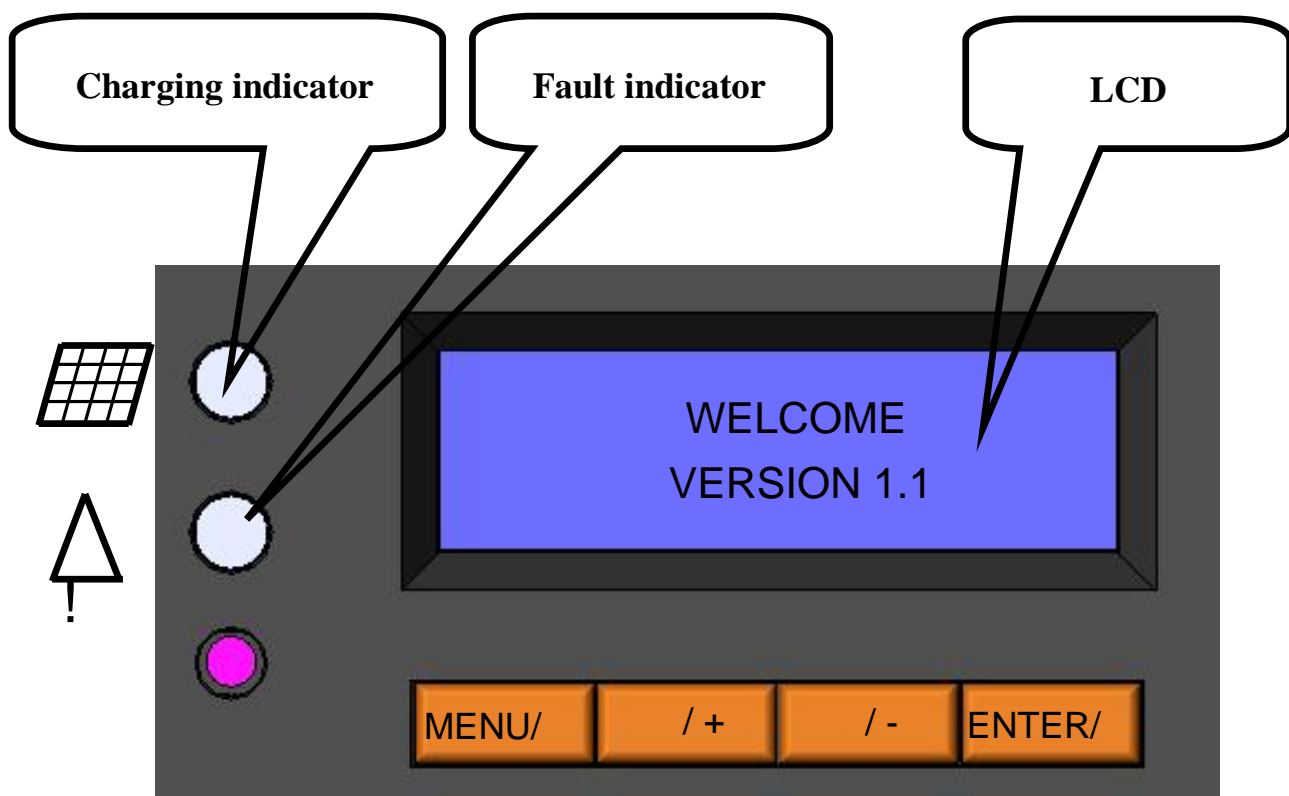

■ Buttons instruction :

MENU/ : Menu / Cursor left button

/ + : Cursor up / Number add button

/ - : Cursor down / Number reduce button

ENTER/ : Enter / cursor right button

Ñ **Charging indicator**

GREEN ON whenever sunlight is available for battery charging,

Charging LED indicator Table 4-1

Color	Indicator	Charging Status
Green	On Solid	Charging

Ñ **Fault indicator**

When the following cases occur, fault indicator red flashing:

Solar module: Over current, Measure error of voltage, Short of counter-attack MOS-I, Short of charging MOS-C, MOS-I or MOS-C disconnection or MOS break in control section;

Battery: Over voltage, Measure error of voltage, Over temp;

Load: Over load, Short, Short of discharging MOS, Measure error of voltage;

Device: Over temp.

For trouble shooting, refer to chapter 5.

Fault LED indicator

Table 4-2

Color	Indicator	Charging Status
Red	Flashing	PV :OverCurrent, Measure Err, MOS-I Short, MOS-C Short, MOS Break
		BATT : OVD, Error, OverTemp
		LOAD : Overload, Short, MOS Short, Error
		DEVICE : OverTemp

4.4 Operation and Displaying of Controller

▮ Load work mode

1. Dusk to Dawn

When solar module voltage goes below the point of NTTV (Night Time Threshold Voltage) at sunset, the controller will recognize the starting voltage and turn on the load after configurable delay time. When solar module voltage goes above point of DTTV (Day Time Threshold Voltage), the solar controller will recognize the starting voltage and turn off the load after configurable delay time.

2. Light ON + Timer

When solar module voltage goes below the point of NTTV (Night Time Threshold Voltage) at sunset; the solar controller will recognize the starting voltage and turn on the load after configurable delay time. The load will be on for several hours which users set.

3. Timer

The mode includes single and double time intervals. Set the starting and ending time for each time interval and controller works according to the set time interval.

4. Manual mode

This mode is to turn ON and OFF the load by manual.

Ñ Operation and displaying of controller

➤ Initialization Interface

When controller is powered on, it turns into initialization, refer to the following picture:



➤ Main Menu Interface

When controller is initialized, it is automatically turned into monitoring interface. Press button **MENU/** to turn into main menu 1 interface which displays the following contents:

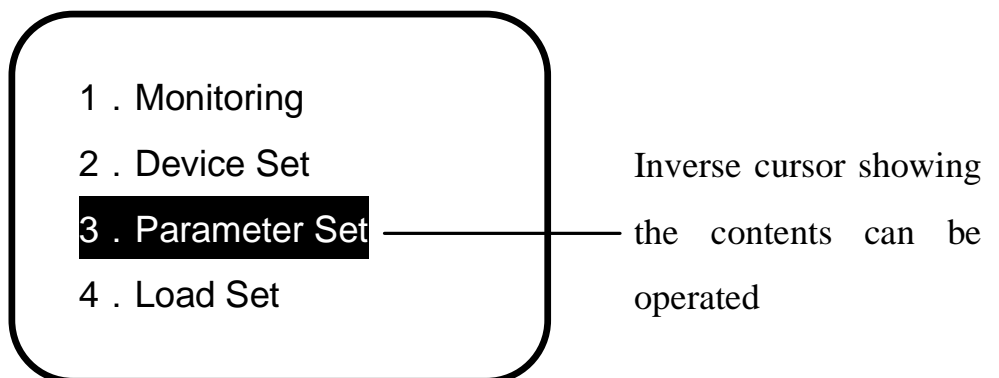

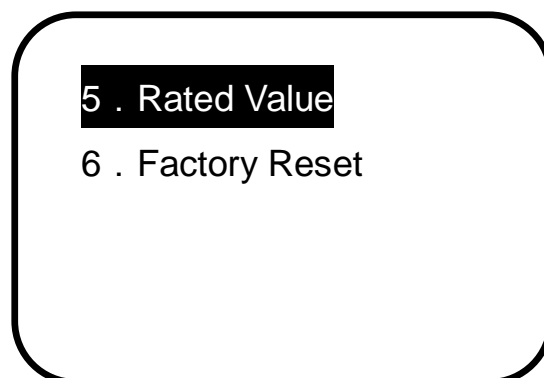

Press the button **/ -** continuously, entering into main menu 2 interface which displays the following contents:

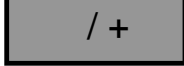
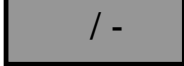

➤ System Monitor Interface

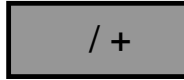
In the main menu interface, when press  or , the inverse cursor moves between main menu 1 and main menu 2. When the inverse cursor rests at

1 . Monitoring in the main menu 1 interface, press  to enter into the system monitoring interface which displays contents as follows. Press  or  to circularly display every real-time parameters interface.

▼ Solar array voltage and current

The interface shows real-time voltage and current of solar module.

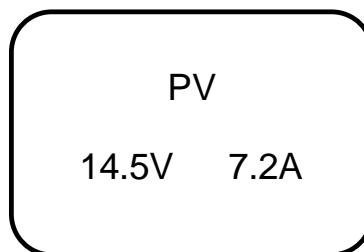

▼ Battery voltage and current

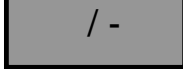
Press  to enter into the following interface which shows real-time voltage and current of battery. Negative indication with current, it means that the battery is in discharging status. Positive indication with current, it means that the battery is in charging status.

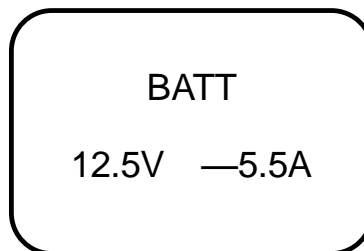

▼ Battery temperature and battery temperature compensation coefficient

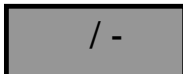
Press  to enter into the following interface which indicates real-time temperature of battery and battery temperature compensation coefficient.

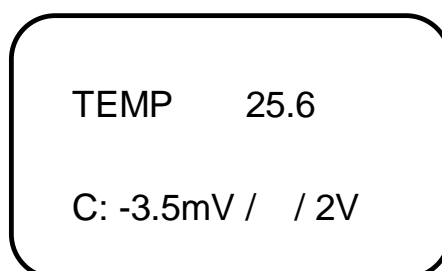

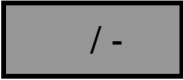

▼ **Load voltage and current**

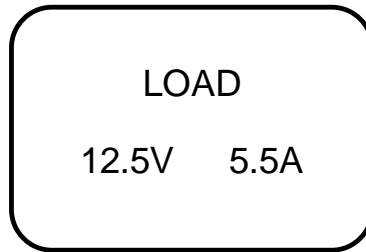
Press  and then enter into the following interface which indicates real-time voltage and current of loads.

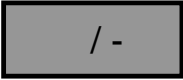

▼ **Real-time clock and imaging system status**

Press  and enter into the following interface which indicates real-time clock and imaging system status. If choose the manual mode with loads, press  in the interface, which can control loads on and off.

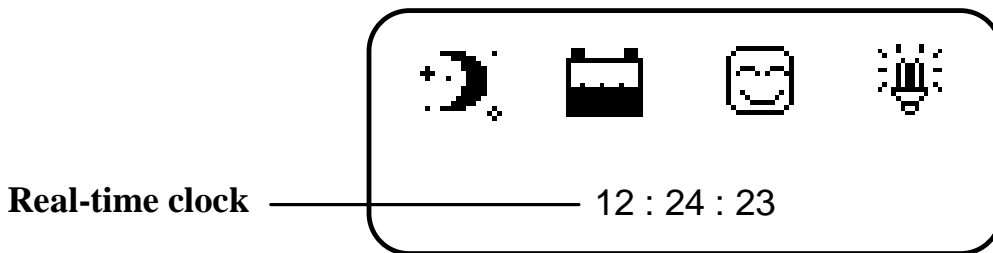

■ **Introductions to system status icons:**

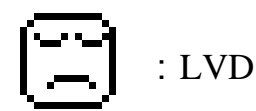
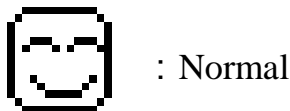

▼ **System status**

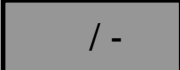
Press  and enter into the following interface which indicates system status.

PV : Disconnect
 BATT : NoCharge / Normal
 LOAD : On
 DEVICE : Normal

PV status :

Connect	Disconnect	Measure Err
Over Current	MOS-I Short	MOS-C Short
MOS Break		

BATT status :

Equalize	Boost	Float
NoCharge	LVD	UVW
Normal	OVD	Error
OverTemp		

LOAD status :



On	Off	OverLoad
Short	Error	MOS Short

DEVICE status :





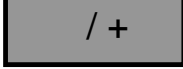

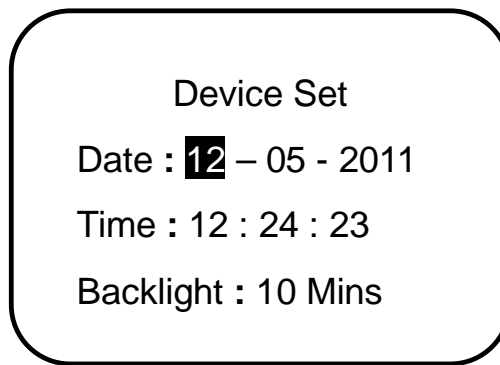

Normal	OverTemp	
--------	-----------------	--

*When fault with inverse cursor appears, if the fault still exists 2 minutes after no button-pressing operation, it is automatically skipped into this page.

➤ Device Setting Interface

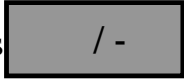
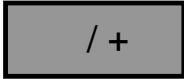
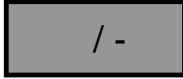
In the main menu interface, press  or , the inverse cursor moves between interfaces of main menu 1 and main menu 2. When the inverse cursor rests on **2 . Device Set** in the main menu interface 1, press  to enter into system setting interface which displays the following contents. When setting in this interface, real time clock will stop running. Please correct real time clock again after parameters are changed.

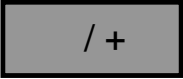
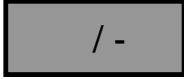

In the interface, press  or , the inverse cursor moves among every parameter. When  is continuously pressed, the inverse cursor moves back to main menu interface. When inverse cursor rests at some parameter, the contents of the parameter can be modified. When modify date and time information, press  to increase the figure and press  to reduce figure. When modify LCD backlight working mode, push  or  the automatic switch on-and-off time of LCD backlight can be set between 00~30 minutes. Only when the inverse cursor moves to option of LCD backlight, can the modified parameters information can be saved. Press , then the following picture appears. Press button  or  to choose save confirmation or save cancellation. After choosing confirmation, press  again, the modified parameters will be saved or cancelled. If choose save cancellation, the inverse cursor returns to main menu

interface. Automatic default off time of LCD backlight is one (1) minute.

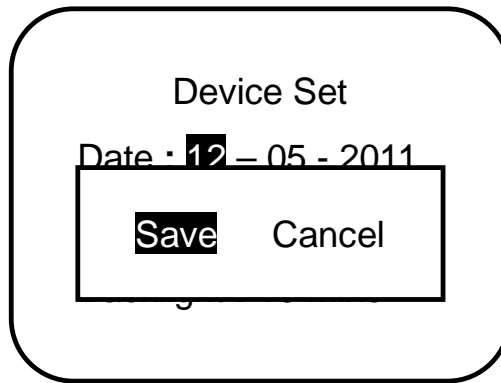

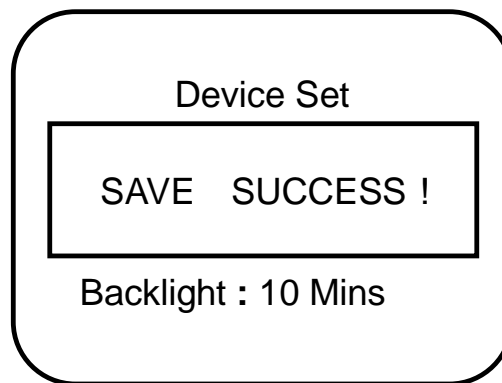

If save confirmation is chosen, the system will automatically check the validity of parameters. If the parameters are reasonably set, the indication of successful saving will occur as follows. After parameters successfully saved, it returns to main menu interface.

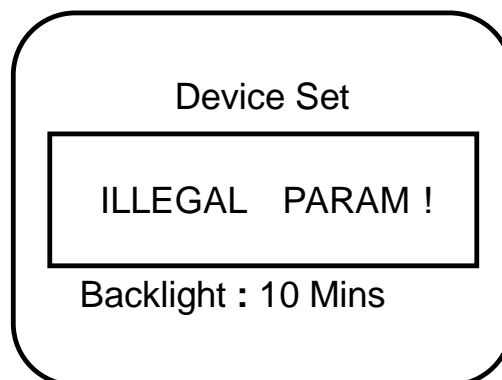

If the following prompt occurs when it is being saved, it indicates failure of saving and parameters setting is illegal. So please verify parameters information.



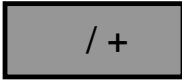
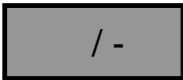

➤ Charging and Discharging Parameters Setting Interface

In the main menu interface, when press  or , the inverse cursor moves between interfaces of main menu 1 and main menu 2. when the inverse cursor rests on **3 . Parameter Set** in main menu 1, press  to enter into charging and discharging parameters setting interface whose displaying interface as follows. When press , it moves back to the previous interface and the inverse cursor rests on the position of the first parameter.

*Control voltage setting please in strict accordance with Over Volt. Disc > Charg Lmt > Equal > Boost > Float > Boost V. Rect or Under V. Rect > Under V. Warn > Low V. Disc > Discharg Lmt , Please refer to chapter 6 control voltage table while setting.

▼ Temperature compensation coefficient

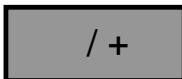
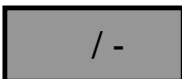
Press  or , then the inverse cursor moves among every parameters. When  is continuously pressed, the inverse cursor returns to the main menu. Press  or  to modify temperature compensation coefficient.

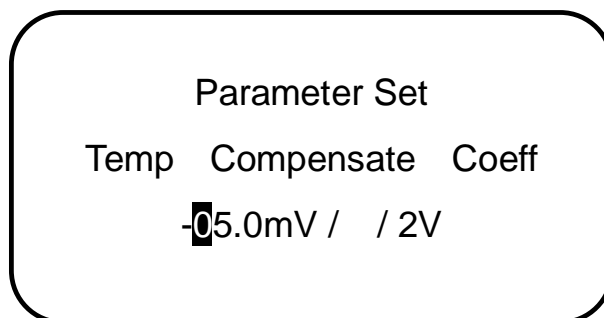

▼ **Control parameters interface**

Press **ENTER/** continuously and the inverse cursor will enter into the control parameters interface. Press **/ +** or **/ -** to modify the following control parameters.

Parameter Set
Over Volt. Disc : **16.0V**
Charg Lmt : 15.5V
Over Volt. Rect : 15.0V

Parameter Set
Equal Chrg : **14.6V**
Boost Chrg : 14.4V
Float Chrg : 13.8V

If battery type is GEL,
the parameters cannot be
modified.

Parameter Set
Boost V. Rect : **13.2V**
Low V. Rect : 12.6V
Under V. Rect : 12.2V

Parameter Set
Under V. Warn : **12.0V**
Low V. Disc : 11.1V
Discharg Lmt : 10.8V

Only when the inverse cursor moves to the option of discharging limit voltage, the modified parameters information can be saved. Press **ENTER/** and the following picture appears. Press **/ +** or **/ -** to choose save confirmation or save cancellation. After choosing confirmation, press **ENTER/** again, the modified parameters will be saved or cancelled. If choose save cancellation, the inverse cursor returns to main menu interface.

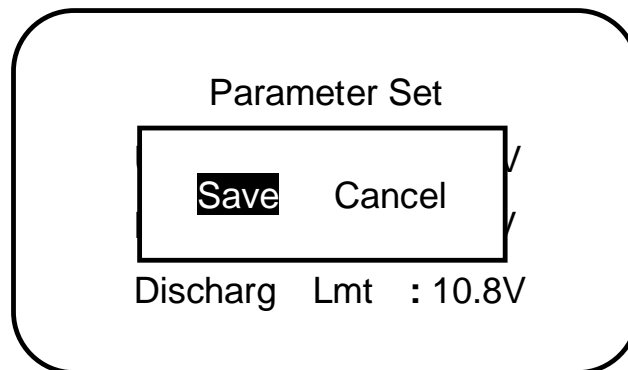

When save confirmation chosen and if the parameters are set reasonably, the indication of successful saving will occur as follows. After parameters successfully saved, it returns to main menu interface.

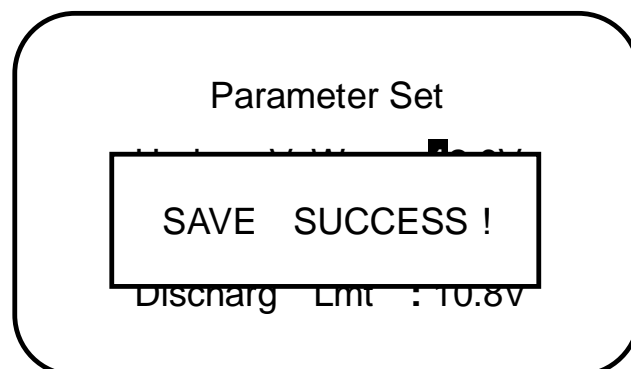

➤ Load Control Interface

In the main menu interface, when press or , the inverse cursor moves between the interfaces of main menu 1 and main menu 2. When the inverse cursor rests on **4 . Load Set** in main menu 1, press and enter load control interface with the following contents displayed.

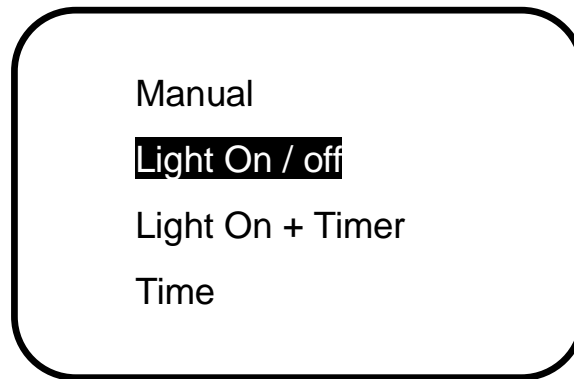

*When set light control threshold voltage, it should meet the requirement :

DTTV (Day Time Threshold Voltage) >= NTTV (Night Time Threshold Voltage)+1V.

Notice: Adjust DTTV (OFF) first and then NTTV (ON).

▼ Manual control interface

Press or to choose load control mode. When the inverse cursor rests on **Manual** in the load control interface, press to enter manual control interface which displays the following contents. In manual control mode, the load will work as previous setting when restart the controller.

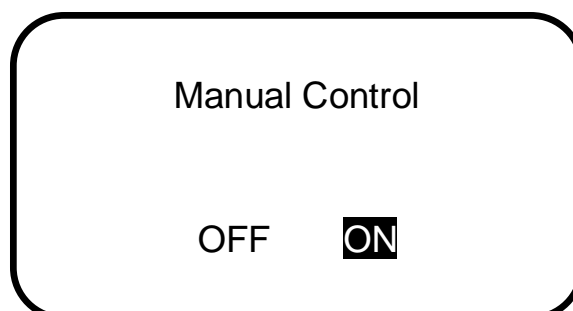

Press **/ +** or **/ -** to choose ON or OFF. After confirmation, press **ENTER/** and the following picture occurs. Push **/ +** or **/ -** to choose save confirmation or save cancellation. After choosing confirmation, press **ENTER/** again. So the modified parameters will be saved or cancelled. When it is cancelled, the inverse cursor moves back to the main menu interface.

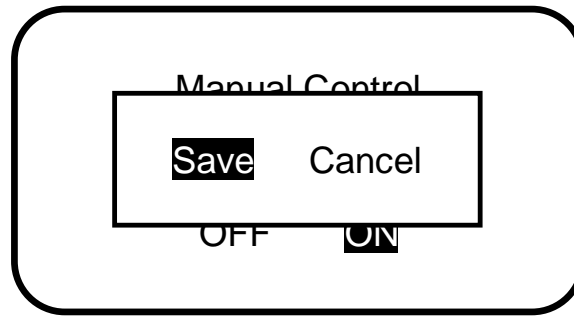

When save confirmation chosen, the indication of successful saving will occur as follows. After parameters successfully saved, it returns to main menu interface.

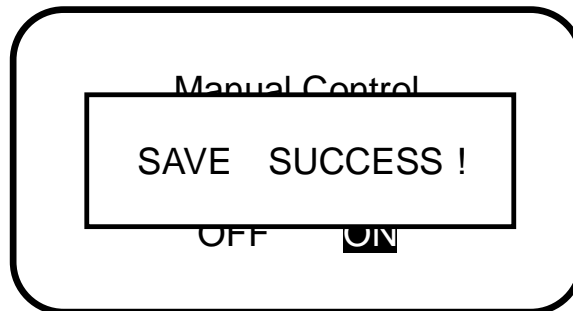

▼ Light control interface

Press **/ +** or **/ -** to choose load control mode. When the inverse cursor rests on **Light On / off** in the load control interface, press **ENTER/** to enter light control interface which displays the following contents.

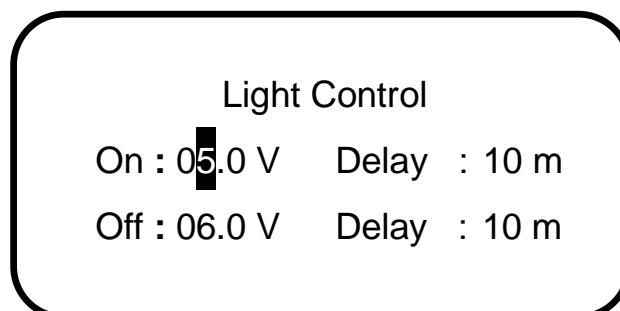

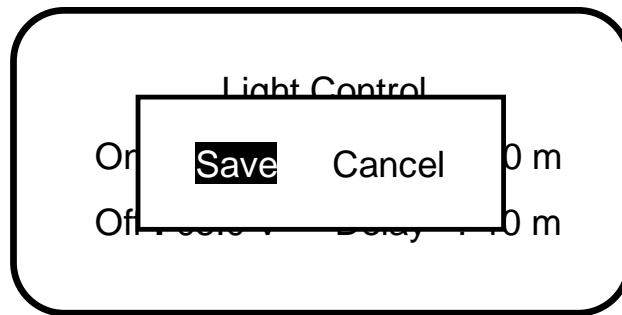

When press **MENU/** or **ENTER/** , the inverse cursor moves among every parameters. When **MENU/** is continuously pressed, it moves back to main menu interface and press **/ +** or **/ -** to modify every parameters. Only when the inverse cursor rests on option of light control off delay, can modification of the parameters be saved. When modification is confirmed, press **ENTER/** , and the following picture appears. Press **/ +** or **/ -** to choose save confirmation or save cancellation. After choosing confirmation, press **ENTER/** again, and the modified parameter can be saved or cancelled. When save cancellation is chosen, the inverse cursor moves back to the main menu interface.



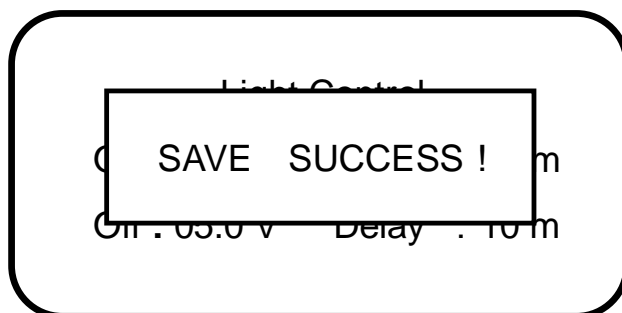



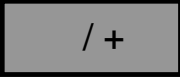
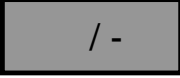

When save confirmation chosen, the indication of successful saving will occur as follows. After parameters successfully saved, it returns to main menu interface.

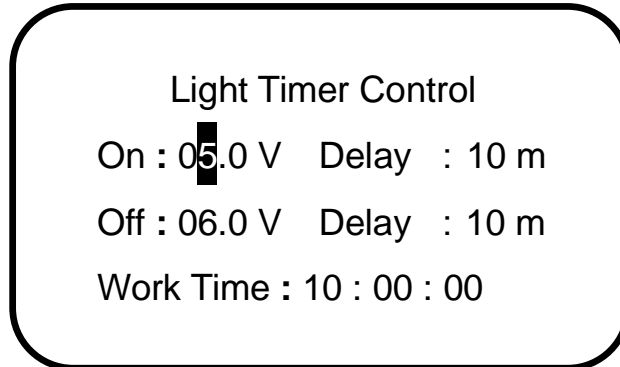

▼ Light control + timer control interface

Press  or  to choose load control mode. When the inverse cursor rests on **Light On + Timer** in the load control interface, press  to enter into light control plus time control interface.

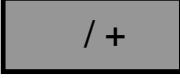

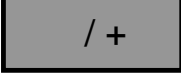
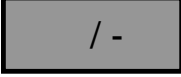
When press  or , the inverse cursor moves among every parameters. When  is continuously pressed, it moves back to main menu interface and press  or  to modify every parameters. Only when the inverse cursor rests on “Work Time” interface, can modification of the parameters be saved. When modification is confirmed, press , and the following picture appears. Press  or  to choose save confirmation or save cancellation. After choosing confirmation,

Press  again, and the modified parameter can be saved or cancelled. When save cancellation is chosen, the inverse cursor moves back to the main menu interface.

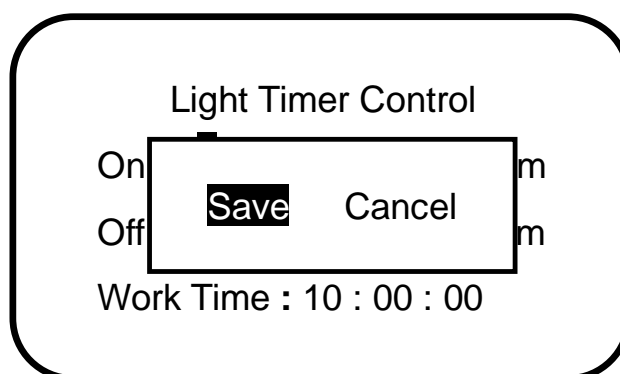



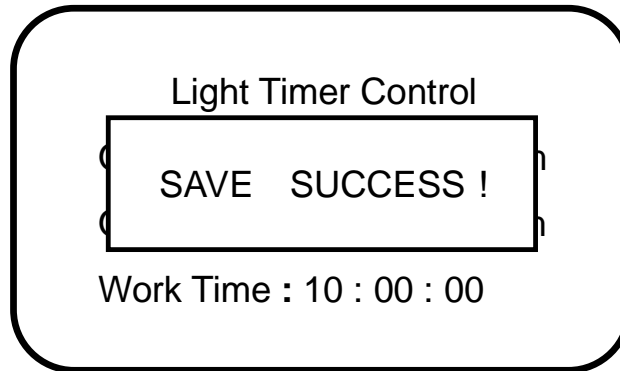

When save confirmation chosen, the indication of successful saving will occur as follows.
After parameters successfully saved, it returns to main menu interface.



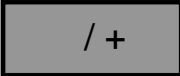
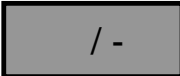

Notes: when the “OFF” time is later than local sunrise time, the controller will turn off the load output at the sunrise time, which shows light control first!

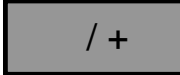
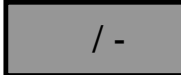
▼ Time control interface

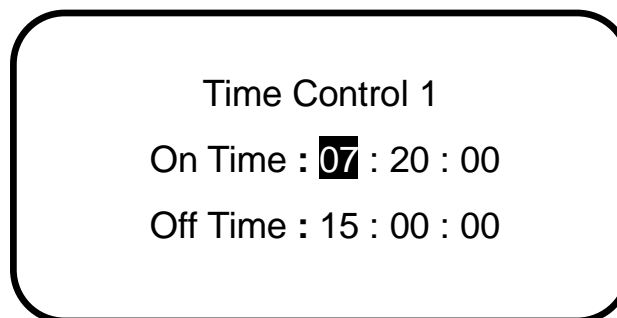
Press  or  to choose time control mode. When the inverse cursor rests on **Time** in the time control interface, press  to enter into time control interface. When press  or , the inverse cursor moves among every parameters. When  is continuously pressed, it moves back to main menu interface and press  or  to modify all parameters of time interval 1.

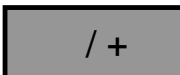
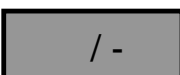

When  is continuously pressed, it will enter into the following interface. When press  or , the inverse cursor moves among every parameters. Press  or  to modify all parameters of time interval 2.

When choose **Double** as time control mode, it is double time interval control.

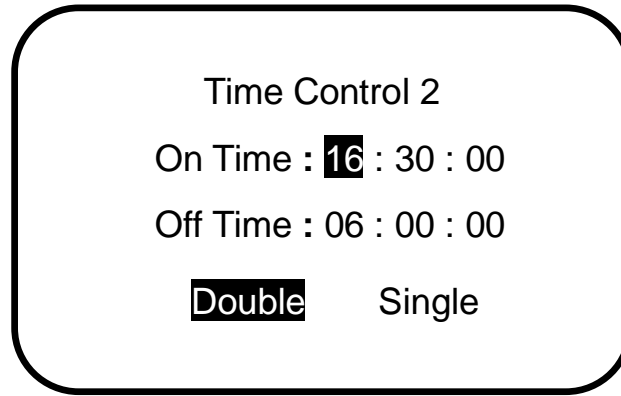

*In the double time work mode, time2 could not be the same as time 1 when Setting.

When choose **Single** as time control mode, it is single time interval control and only parameters of time interval 1 can be modified. The interface is as follows:

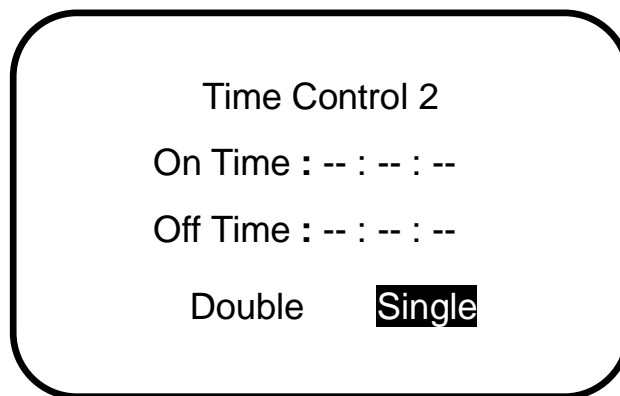

After confirmed, press **ENTER/** , and the following picture appears.

Press **/ +** or **/ -** to choose save confirmation or save cancellation. After choosing confirmation, press **ENTER/** again, and the modified parameters can be saved or cancelled. When save cancellation is chosen, the inverse cursor moves back to the main menu interface.

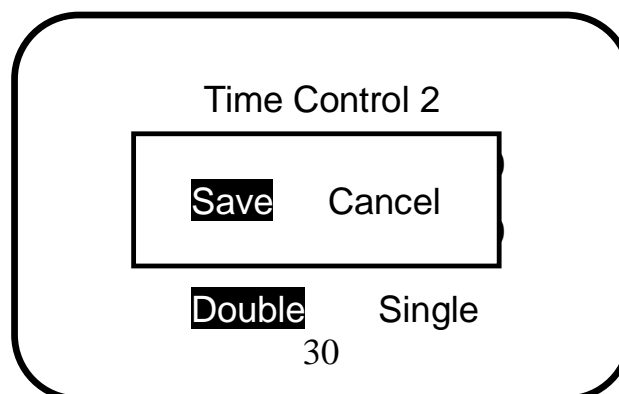

When save confirmation chosen, the indication of successful saving will occur as follows.
After parameters successfully saved, it returns to main menu interface.

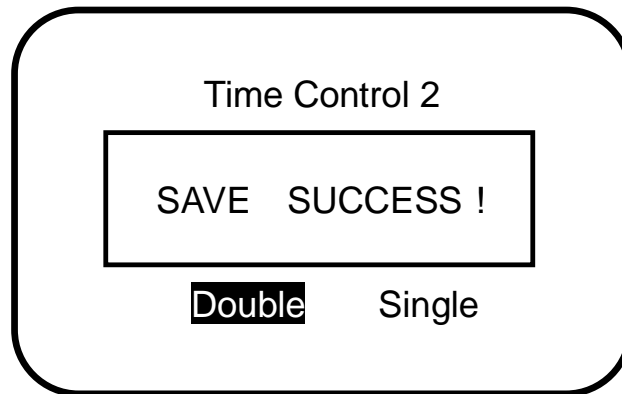

➤ Nominal Parameter Interface

In the main menu interface, when press or , the inverse cursor moves between the interfaces of main menu 1 and main menu 2. When the inverse cursor rests on **5 . Rated Value** in the main menu 1 interface, press and enter into nominal parameter interface with the following contents displayed. In the interface, battery type and capacity can be modified and the modification range is 1-999AH. Press or to modify the relevant parameters.

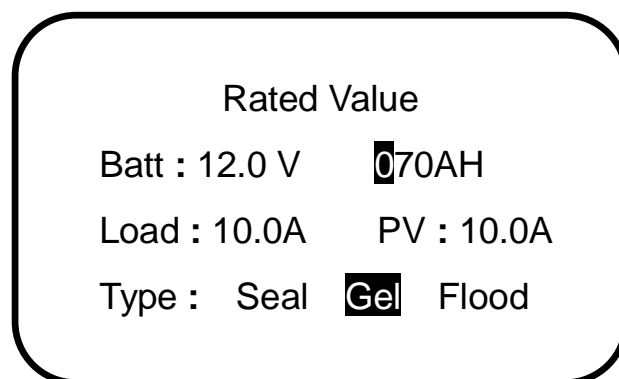

After confirmed, press and the following picture appears.

Press or to choose save confirmation or save cancellation. After choosing confirmation, press again, and the modified parameters can be saved or cancelled. When save cancellation is chosen, the inverse cursor moves back to

the main menu interface.

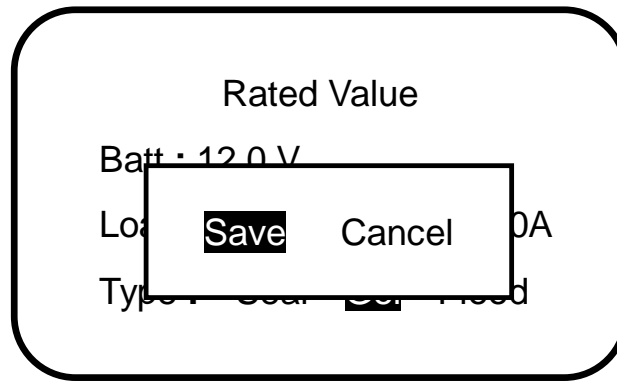

When save confirmation chosen, the indication of successful saving will occur as follows.

After parameters successfully saved, it returns to main menu interface.

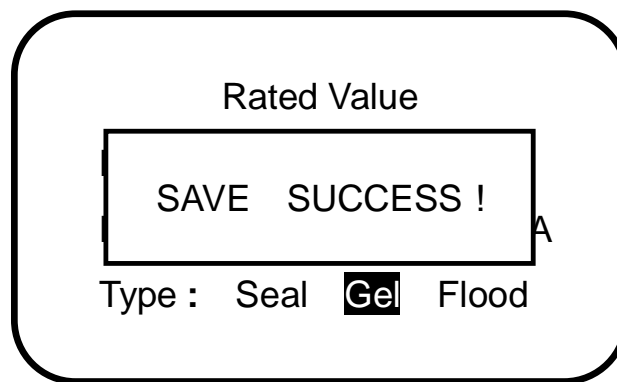

➤ Factory Reset Interface

In the main menu interface, when press or , the inverse cursor moves between the interfaces of main menu 1 and main menu 2. When the inverse cursor rests on **6 . Factory Reset** in the interface of main menu 1, press and enter into factory reset interface with the following contents displayed. Press or to choose whether recover to factory reset.

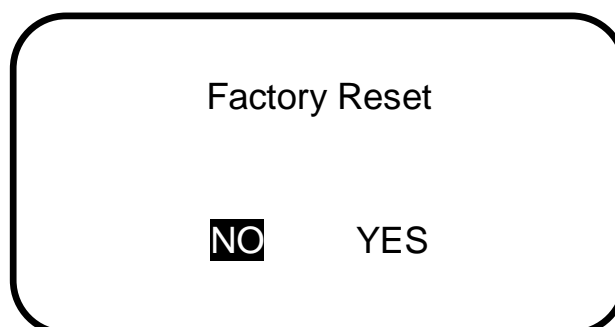

After confirmed, push **ENTER/** and the following picture appears.

Press **/ +** or **/ -** to choose save confirmation or save cancellation. After choosing confirmation, press **ENTER/** again, and the modified parameters can be saved or cancelled. When save cancellation is chosen, the inverse cursor moves back to the main menu interface.

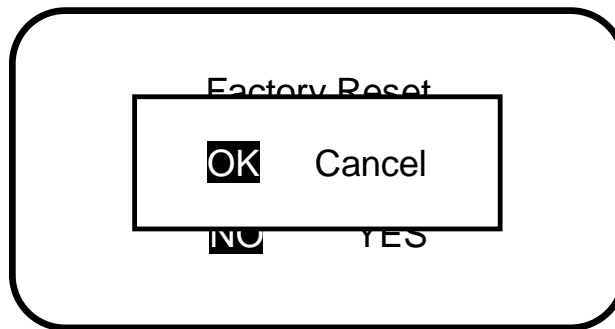

When save confirmation chosen, the indication of successful saving will occur as follows. After parameters successfully saved, it returns to main menu interface.

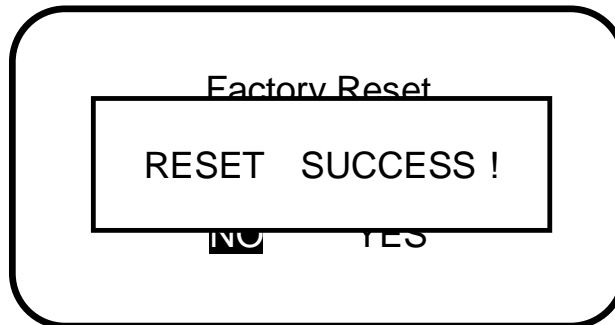

5 Protection, Troubleshooting and Maintenance

5.1 Protection

•PV Array Short Circuit

If PV array short circuit occurs, clear it to resume normal operation.

•Load Overload

If the load current exceeds the maximum load current rating, the controller will disconnect the load. Overloading must be cleared up through reapply power or pressing the setting button.

•Load Short Circuit

Fully protected against load wiring short-circuit. After one automatic load reconnect attempt, the fault must be cleared by reapply power or pressing the setting button.

•PV Reverse Polarity

Fully protection against PV reverse polarity, no damage to the controller will result. Correct the mistake connection to resume normal operation.

•Battery Reverse Polarity

Fully protection against battery reverse polarity, no damage to the controller will result. Correct the mistake connection to resume normal operation.

•Damaged Local Temperature Sensor

If the temperature sensor short-circuited or damaged, the controller will be charging or discharging at the default temperature 25°C to prevent the battery damaged from overcharging or over discharged.

•Overheating Protection

If the temperature of the controller heat sink exceeds 85°C, the controller will automatically start the overheating protection. It recover after it drops to 80°C.

•High Voltage Transients

PV is protected against high voltage transients. In lightning prone areas, additional external suppression is recommended.

5.2 Troubleshooting

Trouble Shooting

Table 5-1

Faults	Possible reasons	Troubleshooting
Charging LED indicator off during daytime when sunshine falls on PV modules properly. the PV of monitoring interface shows Disconnect.	PV array disconnection	Check that PV and battery wire connections are correct and tight.
Charging circuit is off and the PV of monitoring interface shows Over Current.	Charging current is more than nominal current value	Please check whether solar panel array match with nominal parameters of controller; When Charging current reaches 1.05-1.25 times, 1.25-1.5 times and 1.5 times more than nominal value, controller will automatically close loads in 60 seconds, 5 seconds and 1 second, respectively. Controller is automatically circularly activated so as to reconnect charging circuit. Every reactivating is 60 seconds delayed, but not limits on number of times.
Charging and discharging circuit is off and the PV of monitoring interface shows Measure Err , MOS-I Short, MOS-C Short, MOS Break.	MOS-I or MOS-C is damaged.	Please restart controller, if the fault still exists, immediately switch off charging and discharging circuit; contact the supplier to make maintenance.
Loads do not work and the BATT of monitoring interface shows LVD.	Battery over discharged	The controller cut off the output, automatically recovered when fully charged.

<p>Charging and discharging circuit is off and the BATT of monitoring interface shows OVD.</p>	<p>Battery over voltage</p>	<p>Measure and judge if the voltage of battery is too high, and switch off the wiring of solar array.</p>
<p>Charging and discharging circuit is off and the BATT of monitoring interface shows Over Temp.</p>	<p>Operating ambient temperature (local temperature sensor) or battery temperature (remote temperature sensor) over temperature</p>	<p>When operating ambient temperature or battery temperature reaches more than 85°C, controller will automatically cut off input and output circuit.</p> <p>When the temperature is less than 75°C, controller will automatically recover the connection of input and output circuit.</p>
<p>Charging and discharging circuit is off and the BATT of monitoring interface shows Error.</p>	<p>Battery voltage inspection fault</p>	<p>Please restart controller, if the fault still exists, immediately cut off charging and discharging circuit and contact the supplier to make maintenance.</p>
<p>Discharging circuit is off and the LOAD of monitoring interface shows OverLoad.</p>	<p>Load power surpasses nominal power</p>	<p>Please reduce the number of electric equipments. When load power reaches 1.05-1.25 times, 1.25-1.5 times and 1.5 times more than nominal value, controller will automatically close loads in 60 seconds, 5 seconds and 1 second, respectively. It is reactivated after delayed 5 seconds for the first time, 10 seconds for the second time, 15 seconds for the third time, 20 seconds for the fourth time and 25 seconds for the fifth time. If over 5</p>

		<p>times, push the key ENTER and controller recover output after 10 seconds. In the process of 5-time reactivation, if it is recovered manually, the 5-time reactivation will be circulated again.</p> <p>When there is any change from night to daytime, restart the self-recovery process. Namely, 5-time circular reactivation can be operated again.</p>
<p>Discharging circuit is off and the LOAD of monitoring interface shows Short.</p>	<p>Load short</p>	<p>Please check carefully loads connection condition. It is reactivated after delayed 5 seconds for the first time, 10 seconds for the second time, 15 seconds for the third time, 20 seconds for the fourth time and 25 seconds for the fifth time. If over 5 times, push the key ENTER and controller recover output after 10 seconds. In the process of 5-time reactivation, if it is recovered manually, the 5-time reactivation will be circulated again.</p> <p>When there is any change from night to daytime, restart the self-recovery process. Namely, 5-time circular reactivation can be operated again.</p>
<p>Charging and discharging circuit is off and the LOAD of monitoring interface shows MOS-I Short, Error.</p>	<p>Discharging switching tube is damaged.</p>	<p>Please restart controller, if the fault still exists, immediately cut off charging and discharging circuit and contact the supplier to make maintenance.</p>

<p>Charging and discharging circuit is off and the LOAD of monitoring interface shows OverTemp.</p>	<p>Cooling fins of controller over temperature</p>	<p>When the temperature of cooling fins of controller reach 85 °C, the controller will cut input and output circuit; when it is lower than 75 °C, the controller will automatically recover the connection of input and output circuit.</p>
---	--	---

5.3 Maintenance

The following inspections and maintenance tasks are recommended at least two times per year for best controller performance.

- Check that the controller is securely mounted in a clean and dry environment.
- Check that the air flow and ventilation around the controller is not blocked. Clear all dirt or fragments on the heat sink.
- Check all the naked wires to make sure insulation is not damaged for serious solarization, frictional wear, dryness, insects or rats etc. Maintain or replace the wires if necessary.
- Tighten all the terminals. Inspect for loose, broken, or burnt wire connections.
- Check and confirm that LED or LCD is consistent with required. Pay attention to any troubleshooting or error indication .Take necessary corrective action.
- Confirm that all the system components are ground connected tightly and correctly.
- Confirm that all the terminals have no corrosion, insulation damaged, high temperature or burnt/discolored sign, tighten terminal screws to the suggested torque.
- Inspect for dirt, insects and corrosion, and clear up.
- Check and confirm that lightning arrester is in good condition. Replace a new one in time to avoid damaging of the controller and even other equipments.

Notes: Dangerous with electric shock!



Make sure that all power source of controller is cut off when operate above processes, and then make inspection or other operations !

6 Warranty

The VS charge controller is warranted to be free from defects for a period of TWO (2) years from the date of shipment to the original end user. We will, at its option, repair or replace any such defective products.

•Claim procedure:

Before requesting warranty service, check the Operation Manual to be certain that there is a problem with the controller. Return the defective product to us with shipping charges prepaid if problem cannot be solved. Provide proof of date and place of purchase. To obtain rapid service under this warranty, the returned products must include the model, serial number and detailed reason for the failure, the module type and size, type of batteries and system loads. This information is critical to a rapid disposition of your warranty claim.

•This warranty does not apply under the following conditions:

1. Damage by accident, negligence, abuse or improper use.
2. PV or load current exceeding the ratings of product.
3. Unauthorized product modification or attempted repair
4. Damaged occurring during shipment.
5. Damage results from acts of nature such as lightning, weather extremes
6. Irreclaimable mechanical damage.

7 Technical specifications

Model NO :	1024	2024	3024	4024	5024	6024
VS * * * *						
VS * * * * N						
Electrical Parameters						
Nominal System Voltage	12V/24V Auto work					
Maximum Battery Voltage	32V					
Maximum PV Voltage	48V					
Rated Battery Current (A)	10	20	30	40	50	60
Charge Circuit Voltage Drop	0.24V					
Discharge Circuit Voltage Drop	0.16V					
Self-consumption	18mA					
Communication	TTL232 level / RJ45 interface					
Remote temperature sensor interface	2ERJ—3.81					
Ground	VS * * * * 24 : Positive to the ground VS * * * * 24N : Negative to the ground					
Environmental parameters						
Working temperature	-20°C~ +55°C					
Storage temperature	-30°C~ +80°C					
Enclosure	IP30					
Mechanical parameters						
Terminal (mm ²)	4	10	16	35	35	35
Net weight (kg)	0.2	0.4	0.7	0.9	1.2	1.3

Model NO :					
VS * * * *	2048	3048	4048	5048	6048
VS * * * * N					
Electrical Parameters					
Nominal System Voltage	12V/24V/48V Auto work				
Maximum Battery Voltage	64V				
Maximum PV Voltage	96V				
Rated Battery Current (A)	20	30	40	50	60
Charge Circuit Voltage Drop	0.24V				
Discharge Circuit Voltage Drop	0.16V				
Self-consumption	18mA				
Communication	TTL232 level / RJ45 interface				
Remote temperature sensor interface	2ERJ—3.81				
Ground	VS * * * * 48 : Positive to the ground VS * * * * 48N : Negative to the ground				
Environmental parameters					
Working temperature	-20°C~ +55°C				
Storage temperature	-30°C~ +80°C				
Enclosure	IP30				
Mechanical parameters					
Terminal (mm ²)	16	35	35	35	35
Net weight (kg)	0.7	0.9	1.2	1.3	1.5

* Only suitable for acid battery		Gel	Sealed	Flooded
Charging Parameters				
Over Voltage Disconnect Voltage	Upperlimit	17V; ×224V; ×448V		
	Lowerlimit	15V; ×224V; ×448V		
	Default	16V; ×224V; ×448V		
Charging Limit Voltage	Upperlimit	16V; ×224V; ×448V		
	Lowerlimit	14V; ×224V; ×448V		
	Default	15.5V; ×224V; ×448V		
Over Voltage Reconnect Voltage	Upperlimit	16V; ×224V; ×448V		
	Lowerlimit	14V; ×224V; ×448V		
	Default	15V; ×224V; ×448V		
Equalize Charging Voltage	Upperlimit	NC	15.2V; ×224V; ×448V	
	Lowerlimit	NC	14.2V; ×224V; ×448V	
	Default	NC	14.6V ;x2/24V ; ×448V	14.8V ;x2/24V ; ×448V
Boost Charging Voltage	Upperlimit	15V; ×224V; ×448V		
	Lowerlimit	13.8V; ×224V; ×448V		
	Default	14.2V ;x2/24V ; ×448V	14.4V ;x2/24V ; ×448V	14.6V ;x2/24V ; ×448V
Float Charging Voltage	Upperlimit	14.2V; ×224V; ×448V		
	Lowerlimit	13.2V; ×224V; ×448V		
	Default	13.8V; ×224V; ×448V		
Boost Reconnect Charging Voltage	Upperlimit	13.5V; ×224V; ×448V		
	Lowerlimit	12.7V; ×224V; ×448V		
	Default	13.2V; ×224V; ×448V		
Low Voltage Reconnect Voltage	Upperlimit	13.2V; ×224V; ×448V		
	Lowerlimit	12V; ×224V; ×448V		
	Default	12.6V; ×224V; ×448V		

Under Voltage Warning Reconnect Voltage	Upperlimit	12.6V; ×224V; ×448V	
	Lowerlimit	11.8V; ×224V; ×448V	
	Default	12.2V; ×224V; ×448V	
Under Voltage Warning Voltage	Upperlimit	12.4V; ×224V; ×448V	
	Lowerlimit	11.6V; ×224V; ×448V	
	Default	12V; ×224V; ×448V	
Low Voltage Disconnect Voltage	Upperlimit	11.8V; ×224V; ×448V	
	Lowerlimit	10.5V; ×224V; ×448V	
	Default	11.1V; ×224V; ×448V	
Discharging Limit Voltage	Upperlimit	11V; ×224V; ×448V	
	Lowerlimit	10.5V; ×224V; ×448V	
	Default	10.8V; ×224V; ×448V	
Equalize Duration		NC	2 hours
Boost Duration			2 hours
Hreshold Voltage Parameters			
DTTV (Day Time Threshold Voltage)	Upperlimit	10V; ×224V; ×448V	
	Lowerlimit	1V; ×224V; ×448V	
	Default	6V; ×224V; ×448V	
NTTV (Night Time Threshold Voltage)	Upperlimit	10V; ×224V; ×448V	
	Lowerlimit	1V; ×224V; ×448V	
	Default	5V; ×224V; ×448V	
Temperature Compensation Coefficient			
Temperature Compensation Coefficient (TEMPCO)*		-30mV/°C/12V (25°C ref)	

* Compensation of equalize, boost, float and low voltage disconnect voltage.

mm(inches)

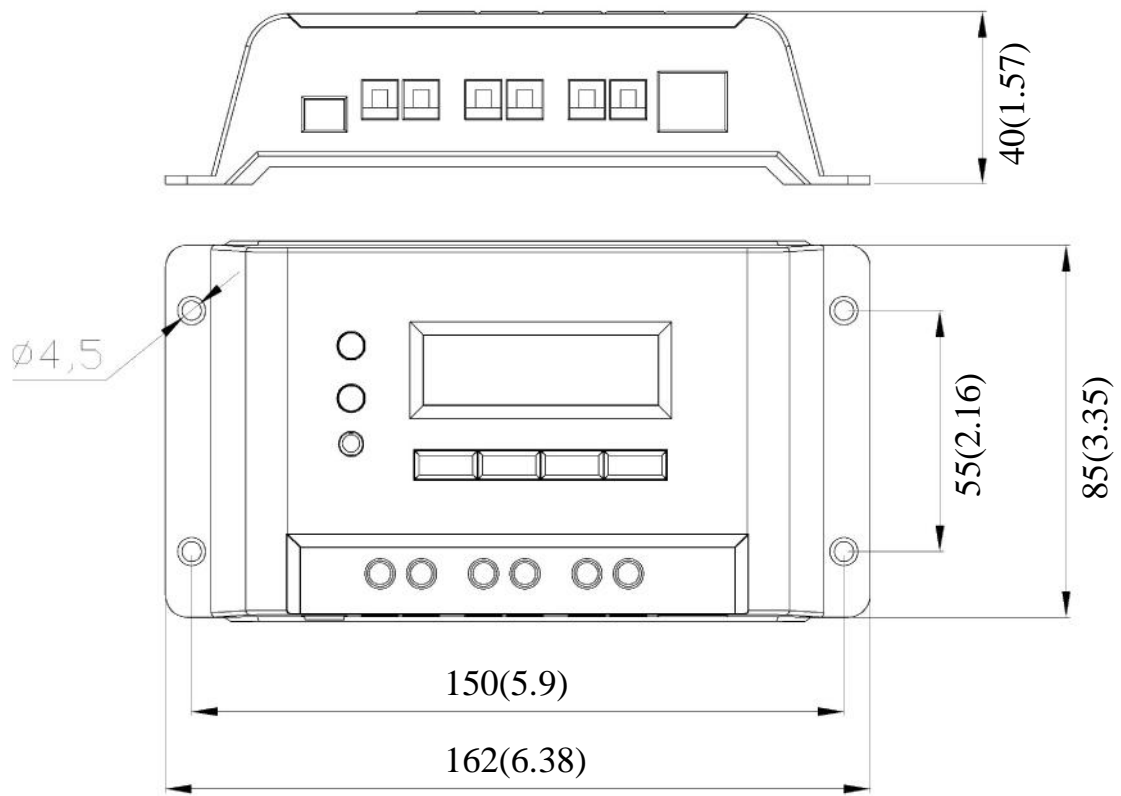

VS1024(N) Dimensions

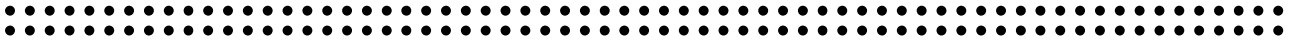

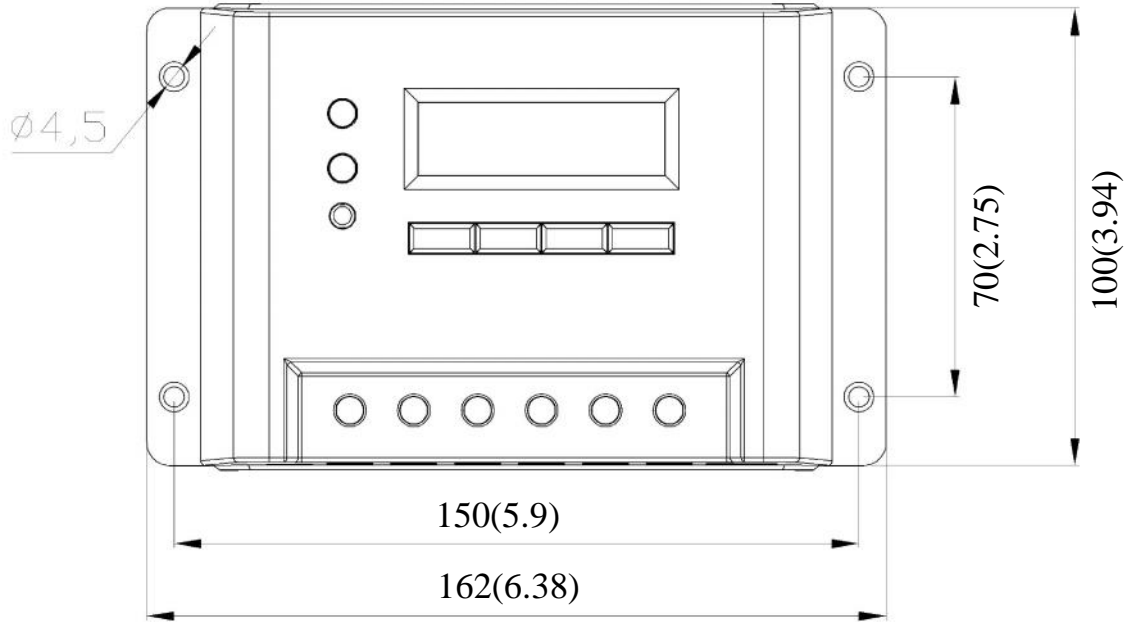
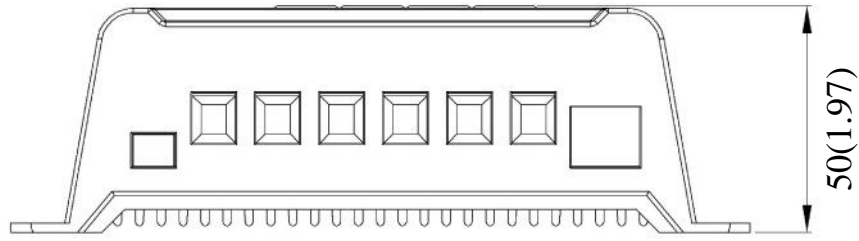

VS2024(N) Dimensions

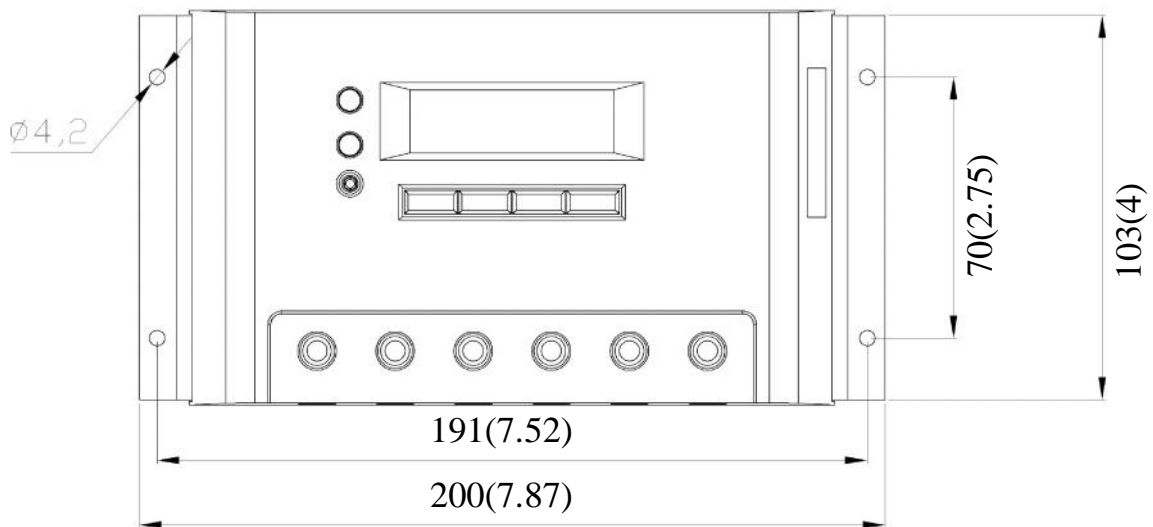
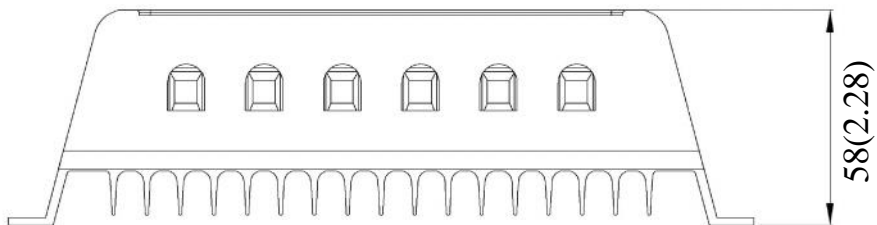

VS2048(N) & VS3024(N) Dimensions

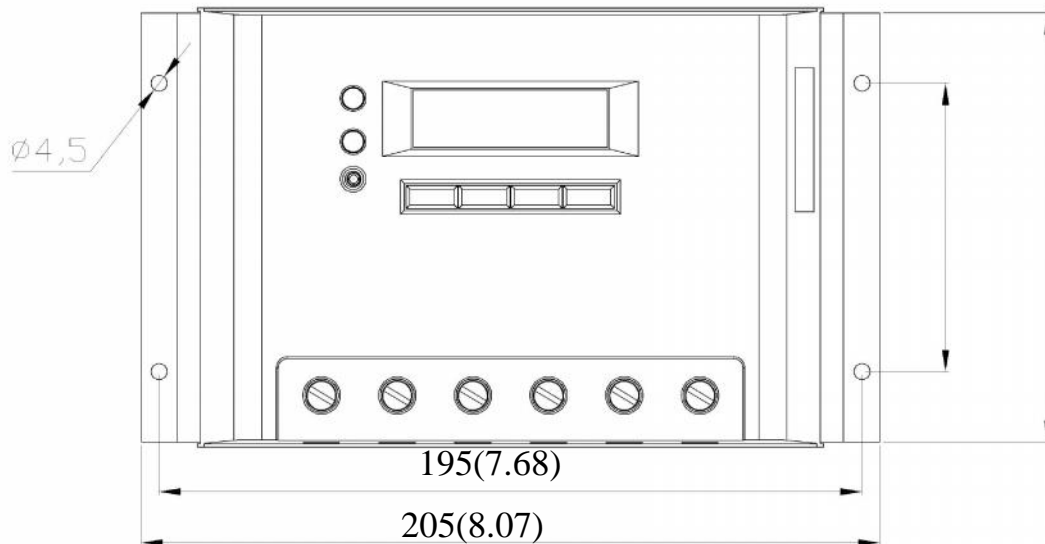
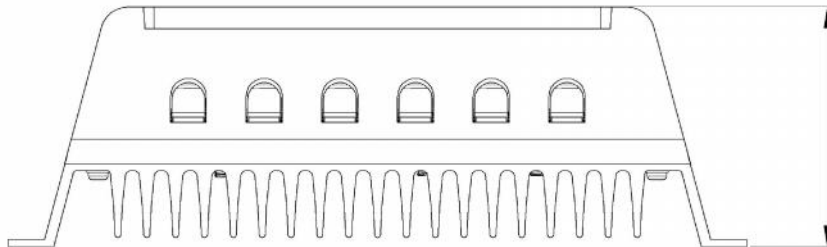
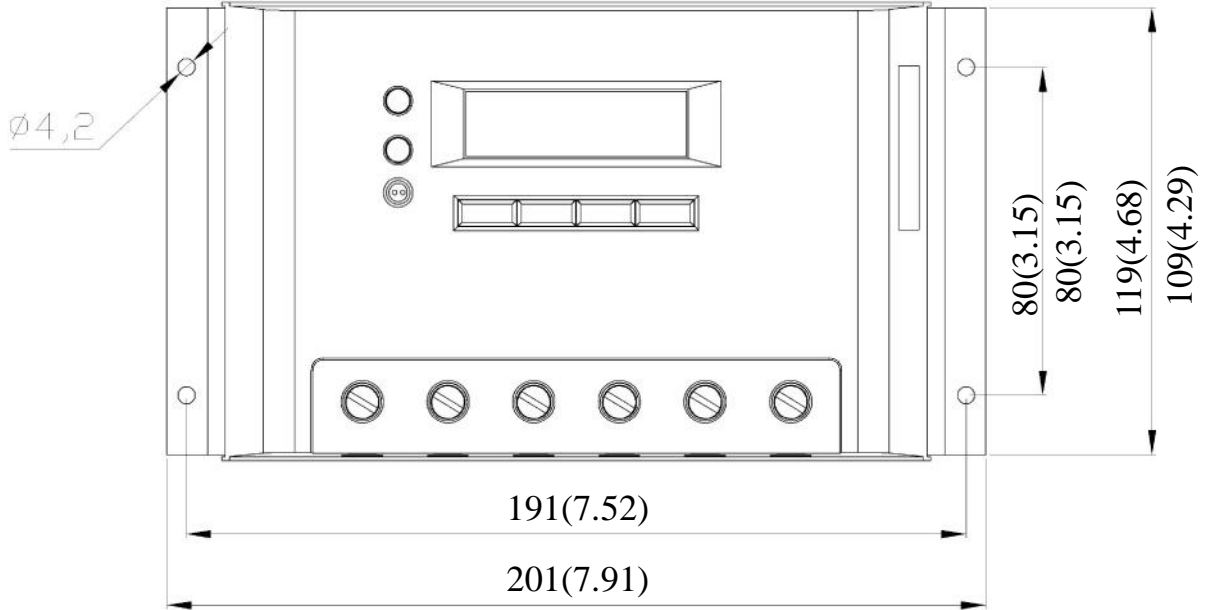
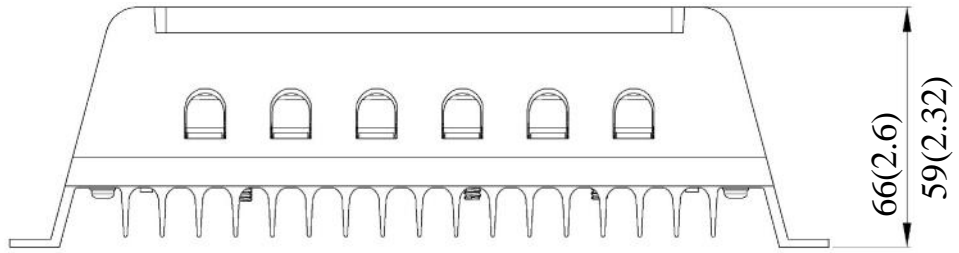
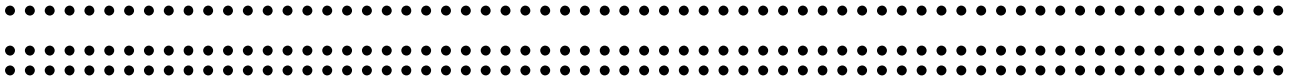

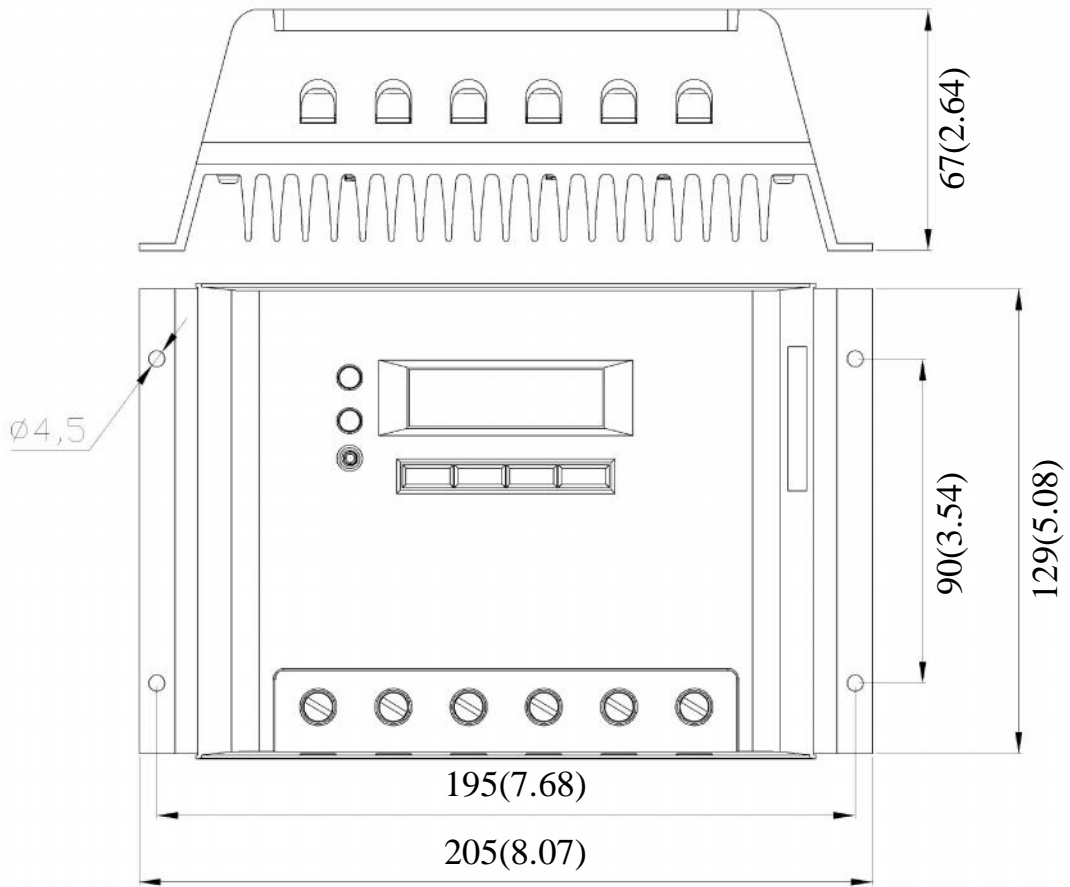
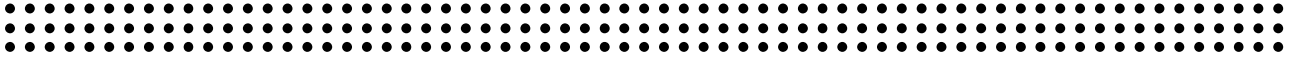

VS5048(N) & VS6024(N) Dimensions

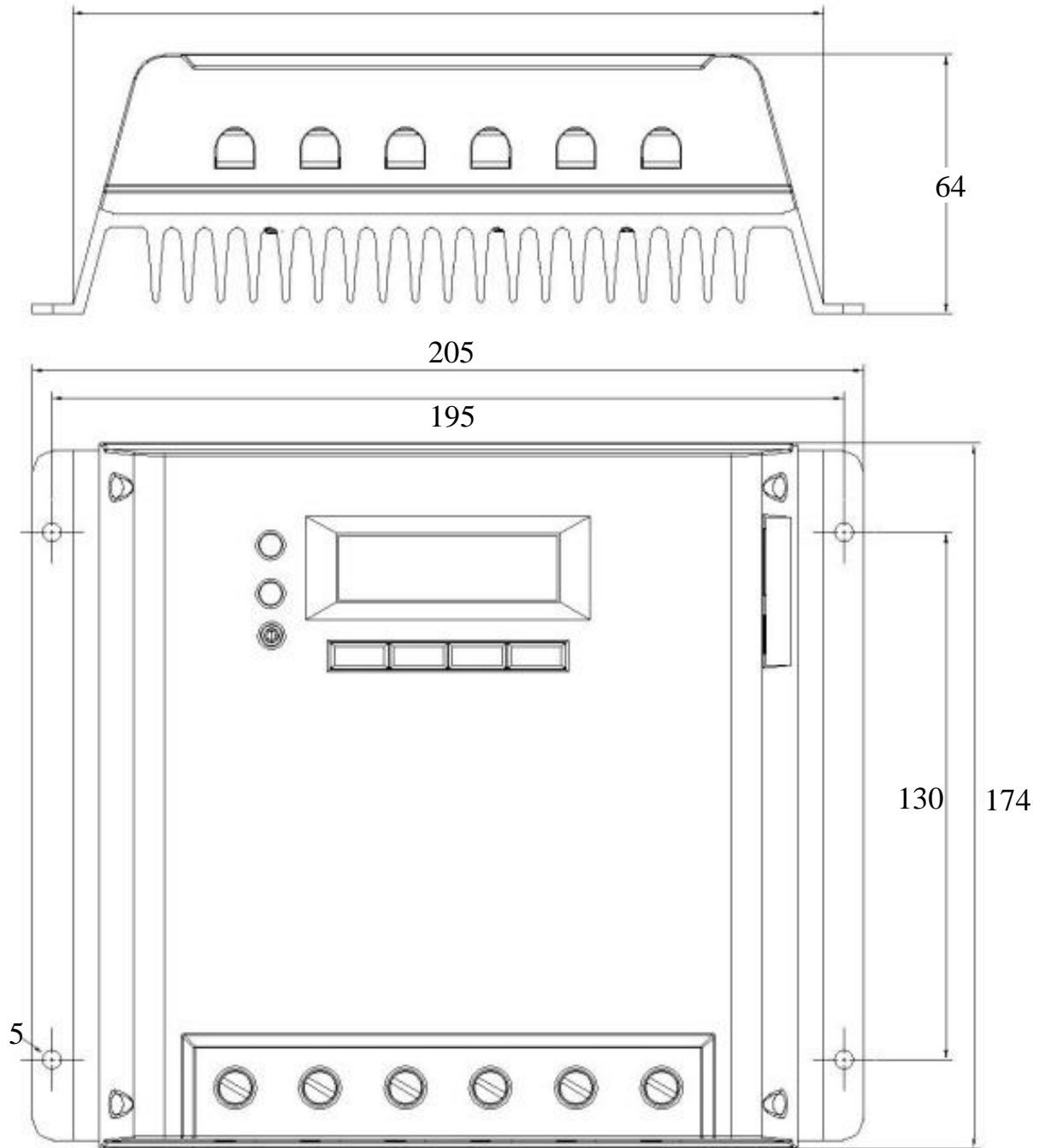

VS6048(N) Dimensions



Westech-Solar Energy GmbH

Tel : +49 89 89545770

Fax : +49 89 89545771

E-mail : info@epsolarpv.de

Website : www.epsolarpv.de

